

+905423924009

ALFTRANS GLOBAL™

DISTRIBUTOR

 **TavSan**
EFFICIENT SYSTEMS

Complete Equipment



www.tavsan.com.tr



WE ARE MANUFACTURING POULTRY EQUIPMENT WITH THE LATEST TECHNOLOGY FOR PRODUCTIVE POULTRY HOUSES

We are one of the oldest and well established companies in Turkey acting in poultry equipment field since 1975.

According to the needs of all kinds of birds in livestock farms; we are manufacturing feeding, watering, ventilation, cooling, lighting systems, feed silos and feed transport systems and climate control systems. We are also offering turnkey projects in case of our customer's requests.

Both in local market as well as in the international markets, our products are preferred with their variety and quality. Our brand is becoming stronger with our performance both in sales and after sales services.

Starting to export for the first time to Libya and Algeria in 1998, today we are exporting over than 50 countries.

We have increased our production capacity, renewed and modernized our manufacturing plant parallel to our increasing sales to new markets and customers and also our increasing product variety. We always improved ourselves since our company's founder, Mr. Cemalettin Bilgin entered this sector on 1969 by producing bell drinkers. Today we carried our production to a 50.000 square meter plant, after establishing our company on 1975 in Laleli, Istanbul in a 60 square meter workshop. We have improved our production and service departments, our quality is

WE WERE ALWAYS FAST AND CAREFUL WHEN PUTTING NEW STEPS

Our quality based studies revert back to us with success in a short time. We added new manufacturing plants to our plant based on 15.000 square meter in Dudullu Istanbul. As our production capacity increased, our product variety also increased. On 2011 we made new investments in order to catch the improving technology as well as increasing demands of our customers.

We built a 35.000 square meter manufacturing plant in Sakarya Industrial Zone equipped with the latest technology and start up on 2012. We kept our management and marketing department in our head office in Istanbul based on 15.000 square meter area and increased our production capacity by moving our production to our new plant in Sakarya industrial zone, composed of 4 new buildings.

Beside our production in European standards, we are the exclusive distributor of 16 foreign companies in Turkey.

We are selling our products through our 10 dealers in the local market and 18 distributors in the international market with 7/24 after sales service and spare part supply guarantee.



certificated by ISO 9001-2008.

We never give up from our policy; “Quality product, quality service, innovative improvement” which keeps customer satisfaction as a first priority.



KNOWLEDGE, TECHNOLOGY AND EXPERIENCE

This is the metal processing plant of TAVSAN. Here, the metal parts of Tavsan equipment is sized, shaped and processed with CNC machines under the control of experienced staff.

HIGH MOTIVATION

Metal workers are manufacturing the metal parts of Tavsan equipments which are competing in the international market against world known brands.



QUALITY AT EACH PHASE

Well trained Tavsan staff, with their quality sense, is preparing the plastic to be used in Tavsan equipment.



Aiming to manufacture quality equipment everytime, the quality control has always the priority

PRODUCTION IN WORLD STANDART

Cimtav, the first group company of Tavsan in Sakarya, is manufacturing the plastic equipments with the latest technologic machines.

EVERYTHING UNDER CONTROL





QUALITY IS GETTING SHAPE

Carefully designed and manufactured parts goes through assembly line and gets the last shape and becomes to be a productive Tavsan equipment.

COMPLETE EQUIPMENT



OUR MODERN WAREHOUSING PLANT

With it's modern warehousing plant, ready to use materials are packed and stocked in 8 tier shelves. Each product is recorded with barcode system.



FAST SHIPMENT



Our warehouse has 1 unloading and 4 loading ramps which allows 4 trucks to be loaded at the same time. All the shipments are recorded with hand terminals.

100 % CUSTOMER SATISFACTION

Customer satisfaction is also very important for us same as the quality of our products and services. Both in local and international markets we are replying any need and questions of our customers before and after sales.

KEMER

Thanks to its hinge system, Kemer feeder can be cleaned easily without the need to separate tray from the pan and it provides time and labor saving. The middle part design does not let the chicks to go inside the feeder in order to keep the feed clean from manure. The conic shaped pan tray distributes the feed equally all around the pan.

**EFES**

EFES pan feeders allows the chicks to reach to the feed starting from the first day with minimum feed loss. The height of the pan and the distance between the grills allows the chicks to get in and out of the feeder easily.

**BODRUM**

The ideal tray height and space between the grill arms in Bodrum feeder let the chicks to enter inside the feed pan during chick period.

**SİDE****999**

The 999 type feeder, which has proven

- Provides chicks to enter into the feeder during chick it's efficiency in broiler houses for many period easily. years, offers easy access from the first day
- Can be used as male feeder. and a very simple installation and cleaning
- Easy and fast cleaning thanks to hinge system. process.
- Conic shaped Belek tray enters the litter and comes to chicken level.

**BELEK / KAŞ**

- The swinging tray of the feed pan allows an easy, fast cleaning with less labor.

- The integrated in feed stopper allows the user to stop the feed to go the pan whenever not needed. This feed stopper also prevents the water to go inside the pan feeding pipe during cleaning.
- Feed flow can be provided equally from the 'chick feeding window' from the feed pan's cone when the system is on the ground.
- The feed height level adjustment on the pan allows easy feed level adjustment in 6 different stages for each pan.



NIPPLE WATERING

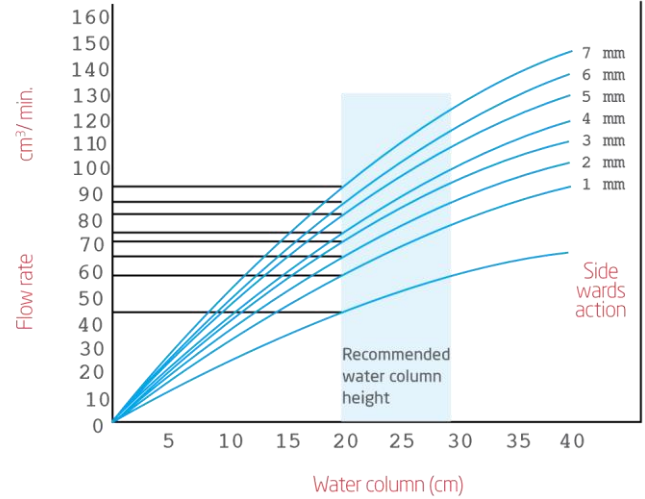

The high-quality stainless steel 'top-nipple' has a flow rate of 30-40cm³/min with sideways and 70-80 cm³/min with upwards (at 3 mm vertical lift action). All flow rates are valid for 20 cm water column. The nipple pipes can either be supplied by an aluminium profile or with a galvanized pipe support. Alternatively the system can be supplied with "top-combi nipple' having the same flow rates.

The only difference is that the outer housing of the stainless steel nipple is covered with a high-quality plastic. Top Nipple and Top-Combi Nipple watering units are available with single-arm and double arm dripcup. The nipples used in TAVSAN nipple watering system are made of top quality stainless steel. The plastic components offer a very long life time with their quality.

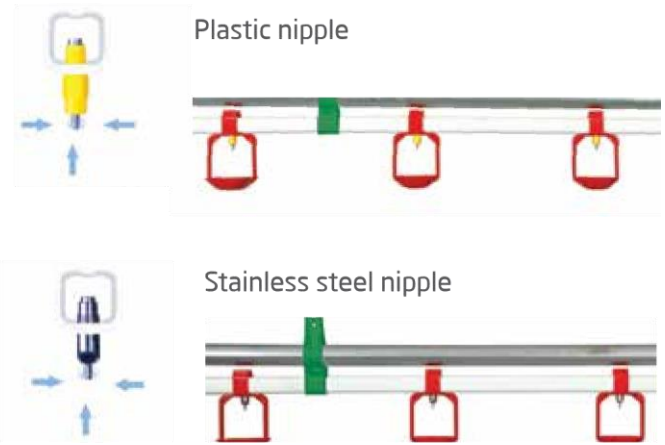

COMBIMASTER NIPPLE



ADVANTAGES

- High quality materials provide highest stability and highest functional safety.
- The nipple body rises only 4 mm inside the nipple pipe to offer much more easy cleaning.
- The extremely smooth inner surface and the outstanding hygienical characteristics of the plastic material avoid deposits.
- The larger body facilitate the birds to identify the nipple easily.

COMPLETE EQUIPMENT

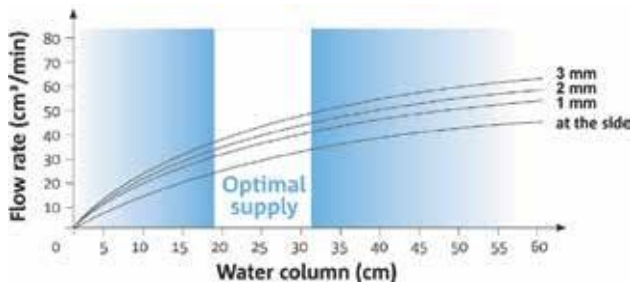

- Easy cleaning.
- Offers water to 12-14 broilers.

COMPLETE EQUIPMENT

MEDICATOR GROUP

This compact product is placed in poultry houses before nipple watering lines which offers all the needed controls for efficient watering.

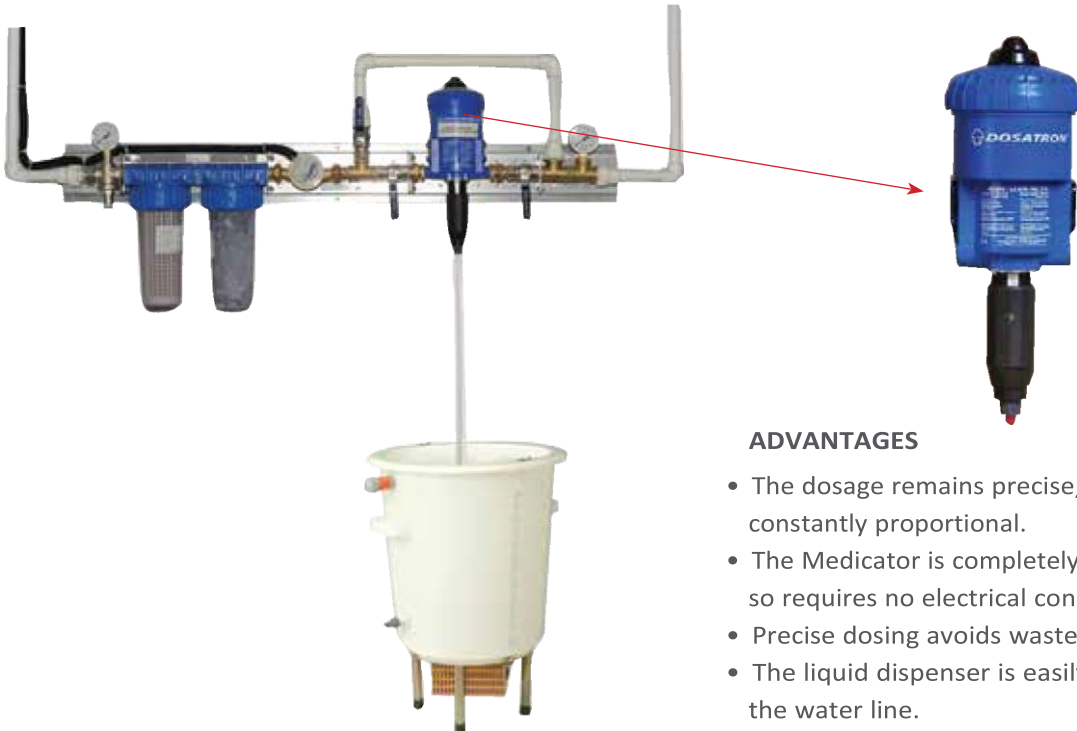

ADVANTAGES

- The dosage remains precise, regular and constantly proportional.
- The Medicator is completely hydraulic and so requires no electrical connections.
- Precise dosing avoids waste.
- The liquid dispenser is easily installed in the water line.

MANUAL FEEDERS & DRINKERS



Suspended Feeder-10 kg



Bucket Feeder- 4 kg



Tray Feeder

TECHNICAL SPECIFICATIONS

Diameter (mm)	352	278	353
Rim height (mm)	67	38	33
Rim width (mm)	33	40	



The corrugated pan surface attracts the chicks to feed and also chick prevents them to sleep on the pan.

5 lt. CHICK DRINKER



BUCKET FEEDER 4 kg TRAY FEEDER

are period of



These two manual feeders suitable to be used in broilers and

also for the first phase of

pullet rearing.

AUTOMATIC DRINKERS



TAV 1C



TAV 2C



YARKA
DRINKER



GÖKSU



FIRAT JUMBO
DRINKER

DICLE BELL DRINKER

The ideal bell drinker that can be used for broilers, layers and breeder rearing. The weight ball mechanism allows the drinkers to work automatically on the floor as well as suspended.



- 1 CORD ADJUSTER
- 2 HANGER CORD
- 3 HOSE HOLDER
- 4 HOSE INLET
- 5 NUT FOR HOSE INLET
- 6 MECHANISM CAP
- 7 FILTER
- 8 O-RING FOR MECHANISM CAP
- 9 MECHANISM PIPE
- 10 WATER LEVEL ADJUSTER
- 11 NUT FOR LEVEL ADJUSTER
- 12 MECHANISM SPRING
- 13 SPRING FOR VALVE
- 14 PIN FOR VALVE
- 15 WASHER FOR VALVE PIN
- 16 WASHER FOR VALVE
- 17 VALVE BODY

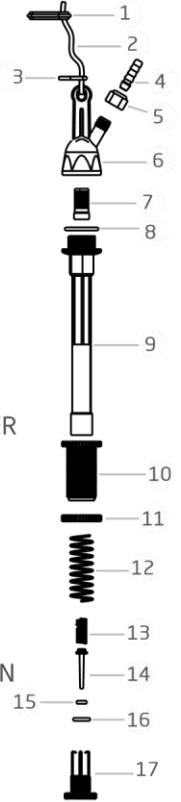

DRINKING SYSTEMS FOR TURKEYS

Perfect Water Supply For Turkeys

The central element of the floor-watering system for turkeys is the turkey nipple. The drinking system gets optimized with the pendulum and the cups for rearing and fattening for every age of turkey.



TURKEY FEEDER

Plastic trays of both feeders are convenient to each other.

Thus, both turkey rearing and breeding can be made in the same poultry house.



Turkey rearing feeder



Turkey finishing feeder



CHAIN FEEDING

- Distributes the feed equally and rapidly throughout the entire house.
- Helps the birds to reach to the feed easier.
- Various alternatives of installation
- Easy installation, maintenance, and cleaning.



Motored winch



Drive unit for suspended chain feeding system



Suspended detachable chain feeding hopper



- Connection bridge for suspended trough
- Hanging wire for trough
- Shock wire fixing unit

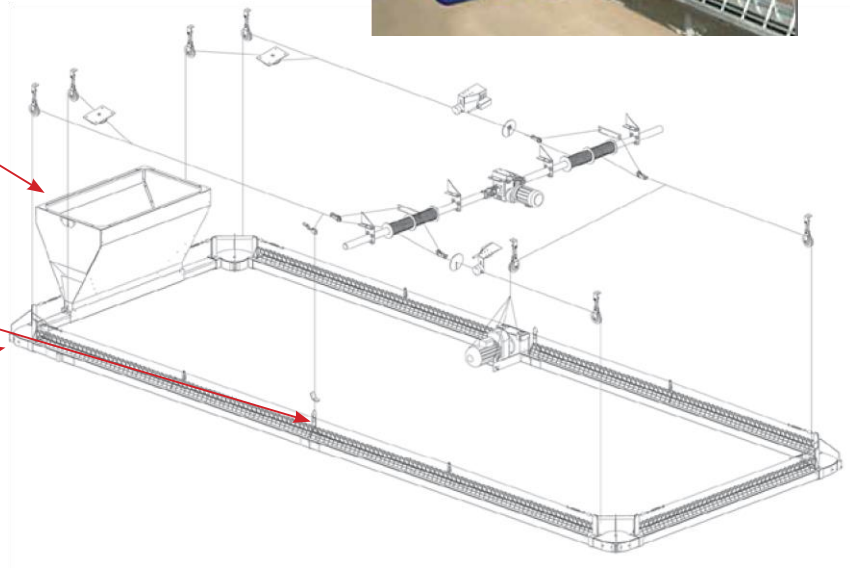
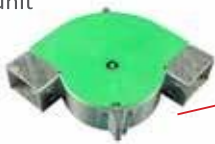

MALE FEEDING

The feeding of the males are done manually or with motor. It is easy to install and use. It has the advantage of distributing the feed equally throughout the line. After the feed is delivered to the feeding line, the lines are lowered to the ground level by manual or motored winches for the males to reach the feed at the same time.

The pan height is suitable for limited feeding and the feed adjustment levels makes this feeder ideal for male feeding in breeder houses. The feed flow can be stopped with the help of the feed stopper inside the feeder cone.



SPIN FEEDER

The spin feeder system distributes the feed equally and quickly to a wide and circular area in rearing houses. It reduces the stress of reaching the feed in the house during feeding.

Roof mounted winchable



Free standing

Tavsan Comfort+



Tavsan **Comfort+** AutomaticNest has a unique shape that is completely different than the conventional automatic nests in the market. Due to the specially constructed design there will be far more air volume and wider area that is greatly contributing to bird's welfare during egg laying.



The nest is almost made of all plastic materials, another curical difference than the existing standard automatic nests. All virgin plastic structure make Tavsan **Comfort+** far more durable in the long term, prevent bacterial growth forming up on the integral side walls and add flexibility and strength to the body.

ADVANTAGES

- Nest with high air volume (0,42 m³ per cell)
- Can be manufactured in 350 -400 mm. heights according to customer preference
- Up to 50% labour saving
- Improved hygiene gg numbers are kept to a minimum
- Specially selected shape and colour for less floor eggs
- High litter quality
- Eggs can be collected any time during the day
- The expel system prevents the birds sleeping in the nest during the night. This offers more clean eggs.
- The nest top is hinged so that the user can open and check inside the nest any time

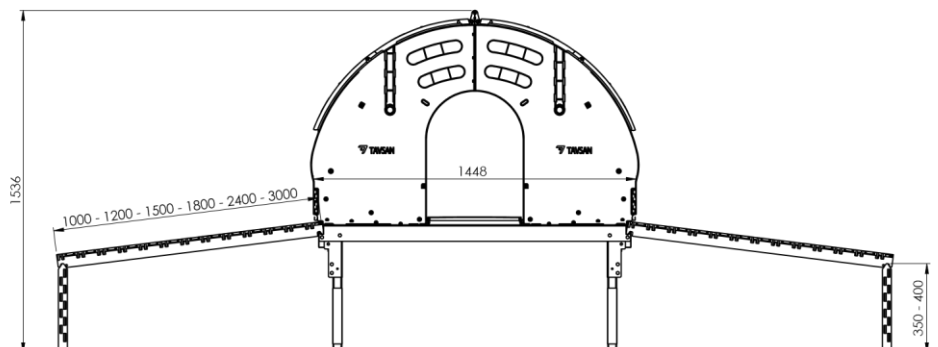
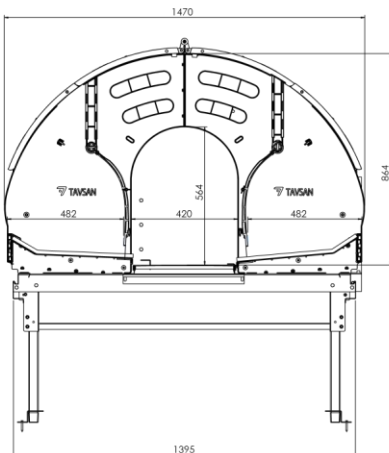

www.tavsan.com.tr

(350 gr/m²) and the corrugation lead to an excellent light reflection and prevent any greenhouse effect inside the silo.

Pneumatic filling is optional. If required, both of the filling alternatives are available in a single silo.

silo body allows you to check the feed level inside the silo.

are designed for maximum safety.

also available as an option for all of our silos.

sheet is 1,2 mm.

Feed in take boot alternatives

ORAGE & TRANSPORT

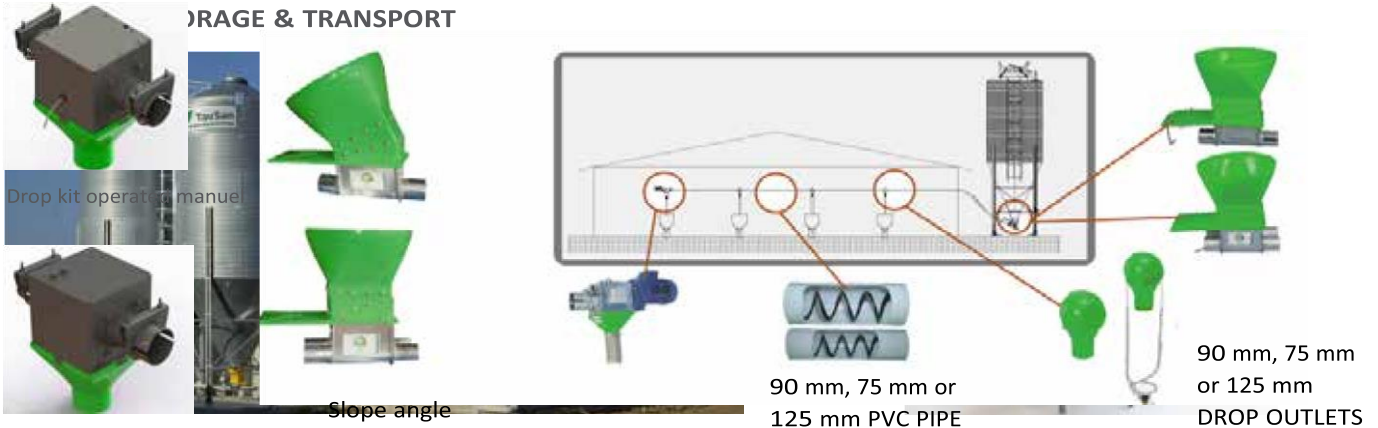

Tavsan silo and flex auger systems offers the user to store and transfer the feed fresh and clean.

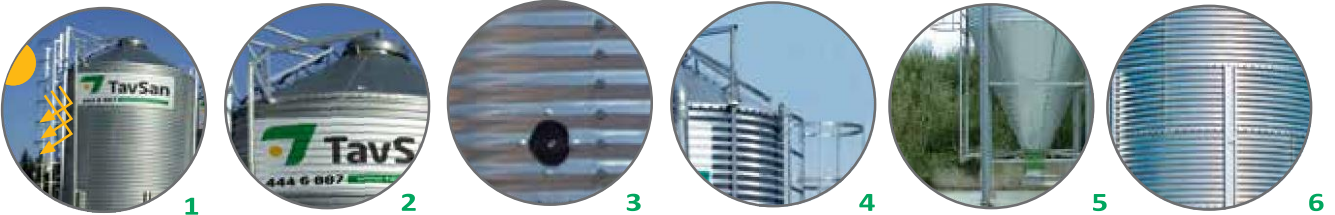

1 The high-quality galvanization

2 Mechanical filling kit is standard in all of our silos.

3 The standard feed view window on the 90 mm, 75 mm or 125 mm DRIVE UNIT

4 The standard ladder, safety cage and handrail

5 Extended ladder to the ground level is

6 The thickness of the funnel and roof

Drop kit with automated valf

MECHANICAL BATCH WEIGHER

Tavsan mechanical batch weigher has a simple and solid structure. It operates for many years without causing any problems. The weigher is suitable to be used for broiler,



layer, and breeder houses. It makes weighing in 10 kg batches.

ELECTRONIC BATCH WEIGHER

It is used to transport the **WEIGHING SYSTEM** required amount of feed to the hoppers inside the house through the manual or automatic drop kits. The feed distribution program that ables the distribution of the feed to the right hopper at the required time with the required amount is done through the suitable processor.



LOADCELL

Feed quantity in the silo can be monitored and restored when used with appropriate controller. Restricted feed delivery is possible.



13 www.tavsan.com.tr TAVSAN ENRICHABLE LAYER CAGE SYSTEM

The dimension of section of unit is composed of 66,5 cm of depth, 64 cm width and 69 cm height. Thanks to 69 cm of height of section, the cage is one of the highest cage in the world.

CAGE SPECIFICATIONS

All system legs are designed per 64 cm by using 2 mm thickness galvanized metal sheets.

TAVSAN Layer Cage System is designed for all weather conditions in the World. The System is composed of 275 gr/m² minimum galvanized metal sheet parts basically; however, all metal parts are designed for different category and tested for high humidity zones of the World by experienced engineers.

TAVSAN FEEDING SYSTEM

The Feeding System is available for both Chain and Feed Trolley. Feed Conversion Rate is tested for both systems and both is working with high efficiency.

Every section has 64 cm of feed through, it provides easy access to feed for 7 Layers at the same time.

The design of system is prepared for European Union regulation and its design is made for easy conversion to Enriched Cage system by using minimum parts.

TAVSAN DRINKING SYSTEM

Nipple lines are 22 x 22 mm pp square pipe and each section includes 3 nipples for 20 birds. There is a "V" canal under of all nipple line.

TAVSAN EGG COLLECTION SYSTEM

The egg collection system is available for both Lift and Elevator. The conveyor system is designed by using plastic pipes and return of conveyor is composed of Radius.

Thanks to special design of the egg collectionsystem, cracked and broken egg number is decreased to minimum

TAVSAN MANURE REMOVAL SYSTEM

"By using top quality (PP) Polypropylene manure and egg belt in TAVSAN Layer Cage System, life of system provides chance of long term use.



TAVSAN REARING CAGE SYSTEM

CAGE SPECIFICATIONS

All system legs are designed per 122.8 cm by using 2 mm thickness galvanized sheet metal.

TAVSAN REARING CAGE SYSTEM

Is designed for all weather conditions in the world. The system is composed of 275 gr/m² minimum galvanized metal sheet parts basically; however, all metal parts are designed for different category and tested for high humidity zones of the world by experienced engineers.

TAVSAN CAGE FEEDING SYSTEM

The Feeding System is available for both Chain and Feed



Trolley. Feed Conversion Rate is tested for both systems and both are working with

The every unit and section has a feed trough which has length of 1228 mm. The Feed troughs are located 122.8 cm for the every section. It provides easy access to feed for "30" one day old chick at the same time.

TAVSAN CAGE DRINKING SYSTEM

Nipple lines are 22 x 22 mm pp square pipe and each section is included 4 Broiler 360 degree nipples with drinking cups. The drinking system is composed of water regulators.

TAVSAN CAGE MANURE REMOVAL SYSTEM

By using top quality (PP) Polypropylene manure and egg belt in TAVSAN Layer Cage System, life of system provides chance of long term use.



COMPLETE EQUIPMENT

VENTILATION

- Long lifetime with high-galvaniz
- High performance with special stainless steel blades.
- Automatic opening-closing shut centrifugal system.
- High isolation with isolation plate each side of the shutters.



TVS Fan 1400



With the help of the centrifugal system the louvers are opened and closed automatically. The louvers does not let the sunlight to go inside the house. It allows easy installation and cleaning.



TVS Fan 960



Conic Fan



Plastic Louvered Fan



TVS Fan 1150 / 810



Circulation Fan



Circulation Fan

LIGHT TRAP

Light traps are assembled in front of exhaust fans and air inlets where light control is specially needed as in breeder houses. It prevents the light to enter to the house. It offers an easy installation and cleaning.



FAN ISOLATION PANEL



- Energy saving for the poultry house during winter terms.
- Light. Easy remove and fix options provide ease of assembly.

- Permanent usage possibility through physical life feature.



TOROS AIR INLET

The TOROS Air inlet can be controlled through the climate controller and can be activated according to the static pressure in order to let the fresh air go inside the house. The air deflectors guide the air with the requested angle.

ILGAZ AIR INLET

Due to its capacity it is used in low quantities in the house which keeps in minimum the isolation losses in the houses. The special design of the door guides the air flow. Ventilation of the poultry houses can be made more economically with the increased airflow capacity of Ilgaz Air Inlet. Ilgaz air inlet's flap also has an insulation material and aluminum profile for maximum strength.

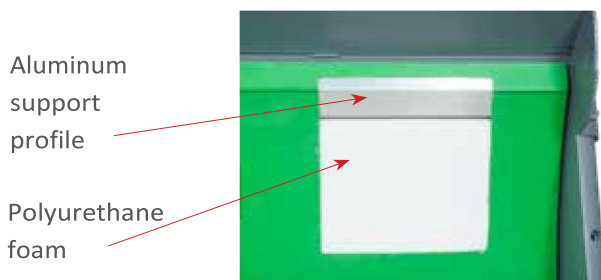
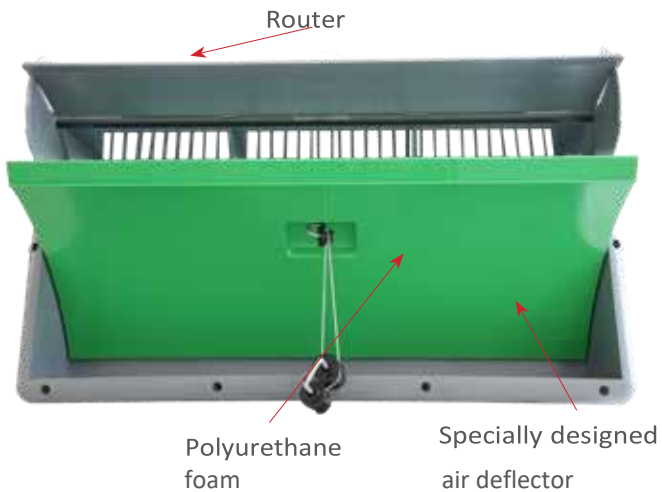

ADVANTAGES

- Less mounting holes through big dimensions, less isolation problem
- Opening and closing options from inside and outside of house
- Providing minimum ventilation all the time with the option of adjusting



COMMON SPECIFICATIONS

- Manufactured from high quality plastic.
- Isolation foam inside the air inlet door offers high isolation.
- The handle on the airinlet door lets the user to open the airinlet door in two steps.
- Stainless steel springs offer perfect air tightness.
- Aluminum profiles inside the air inlet door .



Ilgaz air inlet has 3 option according to opening and closing types.

- 1- Air Inlet opening from the bottom.
- 2- Air inlet opening from the top inside.

3- Air inlet opening from the top outside.

Inlet type	Outer Dimensions		Flange Dimensions	
	Length	Height	Length	Height
Ilgaz inlet	908	454	857	388
Fores inlet	595	325	545	260

COOLING

TUNNEL DOORS

It is recommended to build a dog house (cooling pad room) in poultry houses. The cooling pad room offers an efficient cooling since only the cooled air goes inside the house not the water drips. The tunnel doors let the incoming air to be under control to offer a stable air pressure and speed.

The tunnel doors let the incoming air to be under control to offer a stable air pressure and speed.

The tunnel doors guide the coming air to the ceiling in order not to let the cold air go on the birds.

Isolated doors offers perfect air tightness which does not allow to cold air to go inside the house in winter.



Tunnel Doors



Tunnel inlet system

PAINTED COOLING PAD

- Salt and moss development is decreased.
- It is cleaned by high water pressure and gathered a reinforced product for evaporation.
- Prevention of light transition by dark color and placement of microorganism on cooling pad.
- Doubling of product usage life in case less watering and essential maintenance.



- Its special design provides excellent water dispersion of solid surfaces and mesh structures. This offers excellent wetting, less splashing and therefore excellent cooling capacity.
- The use of high-resistance polymer sheets allows the Plastic Pad to be easily cleaned without damage.

PLASTIC PAD



- Joining polymer sheets by thermal welding guarantees the best stability and a long service life.
- The use of UV stabilizer additives provides high UV resistance.
- Thanks to its polypropylene material, it is highly resistant to many chemicals.

TAURUS

- 3" LCD display
- 8 group fan control
- 3 ea. internal temperature sensor
- 1 ea. external temperature sensor
- 1 ea. humidity sensor
- 1 ea. pressure sensor
- 1 ea. CO2 sensor (optional)
- 1 ea. water consumption tracking
- 1 ea. inlet and curtain control according to pressure
- 1 ea. water pump control for pads
- 4 ea. heating control
- Silo weighing control (optional)
- Live weighing (optional)
- Lighting control and 0-10 volt dimmer control
- Digital batch weigher
- Computer connection, remote control and reporting
- Remote control option with smart phones
- Enter weight of livestock and temperature data according to calendar, automatic calculation of intake air as m^3
- Minimum ventilation option according to air intake as m^3 to the house or stated starting and



stopping time.

ORION

- 7" LCD display
- 16 group fan control
- 4 ea. internal temperature sensor
- 1 ea. external temperature sensor
- 1 ea. humidity sensor
- 1 ea. pressure sensor
- 1 ea. CO2 sensor (optional)
- 1 ea. water consumption tracking
- 1 ea. inlet and curtain control according to pressure
- 1 ea. water pump control for pads
- 3 ea. heating control
- Feed weighing system with electronic batch
- Lighting control and 0-10 Volt Dimmer control
- Computer connection, remote control and reporting
- Remote control option with smart phones
- Enter weight of livestock and temperature data according to calendar, otomatic calculation of intake air in terms of m³
- Minimum ventilation option according to air intake as m³ to the house or stated starting and stopping time.



COMPLETE EQUIPMENT

FORTICA

- 10" LCD touch screen (optional)
- 16 group fan control Dimmer Control
- 4 ea. internal temperature sensor
- 1 ea. external temperature sensor
- 1 ea. humidity sensor
- 1 ea. pressure sensor
- 1 ea. CO2 sensor (optional)
- 1 ea. NH3 sensor (optional)
- Water consumption tracking with electronic water meter
- Air Inlet control according to pressure
- Tunnel Inlet control according to pressure
- Water pump control for cooling pads
- Fogging system control
- 4 ea. heating control
- Loadcell control (optional)



- Bird Weighing Systems control
- Lighting control and 0-10 Volt

- Computer connection, remote control and reporting

- Remote control option with smart phones



- Weight of livestock and requested house temperature data can be entered to the calendar at the software. It is possible to make



automatic control of air intake in terms of m³ according to the entered data.

- Minimum ventilation option according to air intake as m³ to the house or stated starting and stopping time.

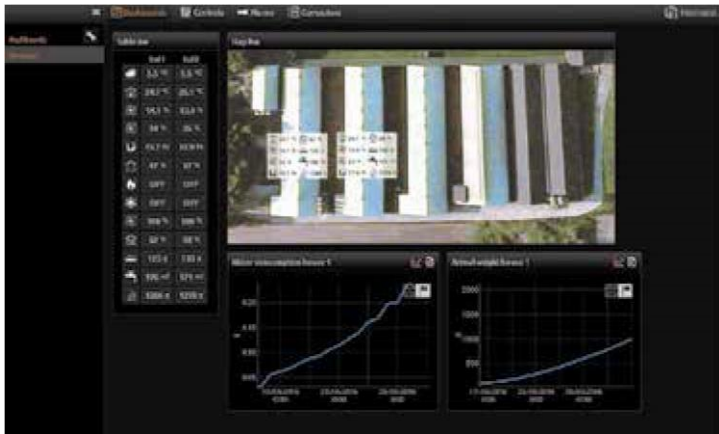

HOT AIR BLOWERS

GA/N series heaters work with natural gas or LPG. With their high air blowing capacity a uniform heating can be obtained throughout the poultry house. Air circulation fans helps the heaters to distribute the hot air in long houses.



GA SERIES HEAT BLOWERS

Optional: In case of applications where the heavy dust treats the heater the user can order “air inlet kit” in order to supply fresh air from outside.



ELECTRIC HEATING SYSTEM / THE DX-EH IS AN ELECTRIC AIR HEATER

Besides the use of “free” energy, electric heating also has a positive influence on the stable climate. No moisture or CO2 is added which needs to be ventilated as with traditional gas heaters. The air humidity remains low and so do the ammonia emissions. This is also beneficial to animal health



DXB DIRECT HEATERS

The DXB heater is a direct fired heaters with an open flame combustion. The efficiency is 100 % as all heat generated remains in the building and is a cost effective heating solution.



BH HEATERS

Gas and Diesel Versions available

- Two Thermal Power: 50kW to 100kW
- Integrated Riello burner (gas or diesel)
- Snorkel kit for fresh air intake
- Housing in Stainless-Steel 430
- IP55 protection
- Full set of accessories

M8 HEATER

A well controlled environment is essential in the first days of the chicks. Experts agree that infrared heat produced from gas



fired heaters provide young birds with their best start. Infrared heaters allows you to heat directly the animals and the floor.



BH100



BH50



Tavsan promotes the poultry sector ahead through its glamorous new led product.

LED LIGHTING (DIMMABLE)

- LED energy saving lamp (6,3W / 35.000 h life time) 220V-50/60 Hz, fixing directly to flat cable.
- Available light colours: warmwhite 3000 K. High efficiency up to 123 lm/W.
- **230 ELECTRONIC DIMMER CONTROL**
- Perfectly dimmable from 2-100% brightness.
- Non flickering light - FI = < 0,03. 220VAC Universal controller/AC-dimmer for LED.
- Fast and flexible fixing.
- Wide beam angle.
- Dust and waterproof IP67.



- Load 1500VA-max.
- intelligent microprozessor-MOSFET-controller.
- Adjustable to trailing-edge or leading-edge- dimming.
- Protection of overheating/overload/shortcircuit/ undervoltage.
- VDE certified and IP20 protection class.
- Power supply 220V-50/60Hz .
- Dimensions: Mounting on DIN Rails 35mm EN60715 Width 6 TE = 105 mm

Voltage	220 - 240V 50/60Hz
Led Driver	%2-%100 dimmable
Ingress Protection	IP 67
Thermal Env.	-10°C - +40°C
Color	3000°K
Weight	80 gr
Lumen / Watt	775 lm / 6.3W
Life Span	Over 35.000 hours
Material	Cover Material: PMMA Base Material: ABS

LED

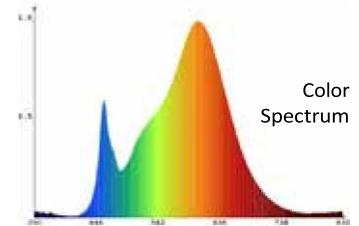

PERFORMANCE CRITERIAS

PIN LED LIGHTING (DIMMABLE)

- LED energy saving lamp (8W- 3000 K - 75W 230V-50/60 Hz, fixing directly to flat cable.
- Available light colours: warmwhite 3000 K. High efficiency up to 112 lm/W.
- Average lifetime > 30.000h.
- Perfectly dimmable from 0-100% brightness with iLOX dimmer EPU-1500.
- Non flickering light - FI = < 0,03.
- Fast and flexible fixing.
- Wide beam angle.

incandescent bulb).



No extra housing needed.

Dust and waterproof IP68.

EPU-1500 ELECTRONIC DIMMER CONTROLLER

220VAC Universal controller/AC-dimmer for LED.

Load 1500VA-max.

intelligent microprozessor-MOSFET-controller.

Adjustable to trailing-edge or leading-edge- dimming.

RS485-digital-interface- communication.

Protection of overheating/overload/shortcircuit/undervoltage.

Alarm signalization by buzzer-beep and LEDs.

VDE certified and IP20 protection class.

Dimensions: 105*90*60mm W*H*D.

60mm

www.tavsan.com.tr

22

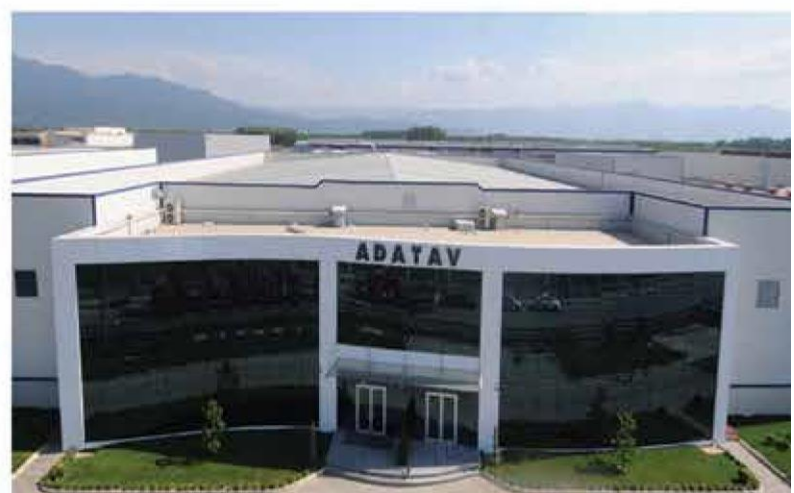

+905423924009

ALFTRANS GLOBAL™

DISTRIBUTOR

Ataturk Bulvar, Emlak Bank, Aksaray, Kemalpasha
Mahallesi Apt A block No:34/7, 34134 Fatih/İstanbul

www.alftransglobal.com

Tavsan Tavukçuluk Ekipman San. ve Tic. A.Ş.

Şerifali Mahallesi Mevdudi Sokak Tavsan Plaza No:10 34775 Ümraniye, İstanbul / TÜRKİYE
T. +90 444 6 887 / F. +90 (216) 364 66 30 / tavsan@tavsan.com.tr / www.tavsan.com.tr

10/2024

TAVSAN reserves the right, without prior notice or liability, to make changes in the equipment design and technical specifications.